

BUCCANEER FOR DATA

6000 Series Ethernet Buccaneer

Thermo-plastic version



Patch Cord Flex Connector - Pur Jacket Cable



PXP6037

- Mates with PXP6033TP type panel mounting connectors
- 30° twist locking
- Overmoulded patchcords with IP rated connector
- Supplied with shielded RJ45 plug
- Single or double end terminated
- Standard lengths: 2m, 3m&5m
- S-FTP cable construction
- PUR jacket cable
- Wiring configuration to 568-B
- Exceeds EIA/TIA Cat 5e

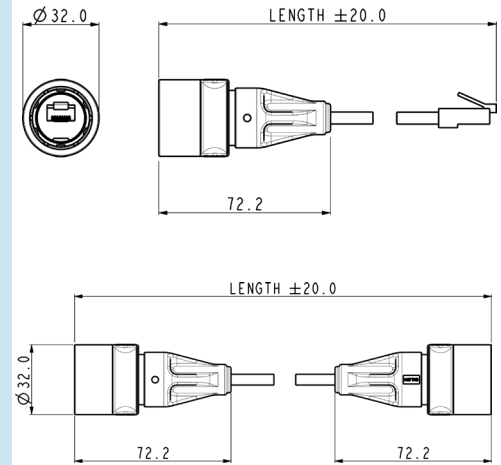

Part no	Type	Length	Description
PXP6037/2M00	Single ended	2m	IP RJ Buccaneer to Shielded RJ45
PXP6037/3M00	Single ended	3m	IP RJ Buccaneer to Shielded RJ45
PXP6037/5M00	Single ended	5m	IP RJ Buccaneer to Shielded RJ45
PXP6038/2M00	Double ended	2m	IP RJ Buccaneer to IP68 RJ Buccaneer
PXP6038/3M00	Double ended	3m	IP RJ Buccaneer to IP68 RJ Buccaneer
PXP6038/5M00	Double ended	5m	IP RJ Buccaneer to IP68 RJ Buccaneer

Rewireable Flex Connector



PXP6034

- Mates with PXP6033TP type panel mounting connectors
- 30° twist locking
- Supplied with shielded RJ45 plug
- Two versions:
for PUR jacket cable (Cat 5e)
for other cable sizes from
4.0 to 10.0mm dia.

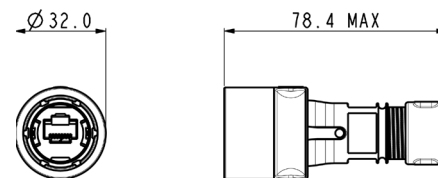

Part no	Description
PXP6034/A	Cable glands optimised for PUR jacket cable to maintain Cat 5e performance
PXP6034/B	Suitable for use with cables from 4.0 to 10.0mm diameter

Front Panel Mounting Connector



PXP6033TP

- Sealed through panel
- Cat 5e shielded coupler
- Mates with all plastic flex connectors
- Standard RJ45 patchcord can be plugged into rear
- Version with earth wire available
- Single hole fixing
- Complete with panel sealing gasket

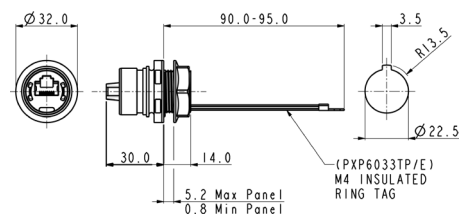

Part no	Description	Fixing
PXP6033TP	Cat 5e coupler	Front panel mounted - sealed through panel
PXP6033TP/E	Cat 5e coupler + earth wire	Front panel mounted - sealed through panel

BUCCANEER FOR DATA
6000 Series Ethernet Buccaneer

- Metal version



Re-wireable Flex Connector



PXM6034

- Mates with PXM6033TP type panel mounting connectors
- 30° twist locking
- Supplied with shielded RJ45 plug
- Two versions:
for PUR jacket cable (Cat 5e)
for other cable sizes from 4.0 to 10.0mm dia.

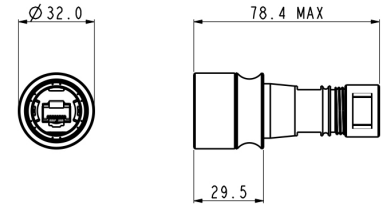

Part no

Description

PXM6034/A	Cable glands optimised for PUR jacket cable to maintain Cat 5e performance
PXM6034/B	Suitable for use with cables from 4.0 to 10.0mm diameter

Front Panel Mounting Connector



PXM6033

- Sealed through panel
- Cat 5e shielded coupler
- Mates with PXM6034 type flex connectors
- Standard RJ45 patchcord can be plugged into rear
- Connector shell ground to cable screen
- Single hole fixing
- Complete with panel sealing gasket

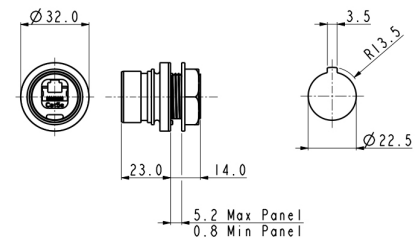

Part no

Description

Fixing

PXM6033TP	Cat 5e coupler	Front panel mounted - sealed through panel
-----------	----------------	--

Accessories For Ethernet Connectors



PXM6034

- Plastic connectors
- PXP6081 for cable connectors
 - PXP6034, PXP6037 & PXP6038
 - PXP6083 for front panel mount connectors PXP6033, with 30° twist lock

Sealing caps to maintain IP rating when connectors are not in use

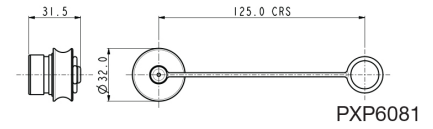

PXP6081

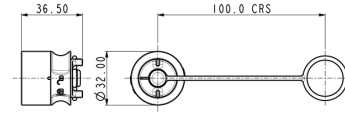

PXP6083

Part no **Description**

PXP6081	Sealing Cap for plastic Flex cable connectors
PXP6083	Sealing Cap for plastic front panel mounting connector

Accessories For Ethernet Connectors



PXM6033

- Metal connectors
- PXM6081 for cable connectors
 - PXM6034
 - PXM6083 for front panel mount connectors

Sealing caps to maintain IP rating when connectors are not in use

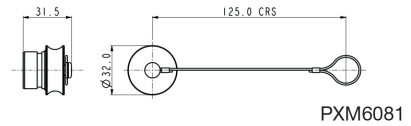

PXM6081

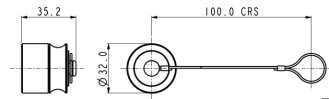

PXM6083

Part no **Description**

PXM6081	Sealing Cap for metal Flex cable connectors
PXM6083	Sealing Cap for metal front panel mounting connector

14151	Hand crimp tooling + die set
14199	PUR Jacket cable - 50m reel
14150	Replacement shielded RJ45

BUCCANEER FOR DATA
6000 Series Ethernet Buccaneer

Part No System



Series Designation

PXP - Plastic
PXM - Metal

Series / Body Style

033 = Panel
034 = Re-wireable Flex
037 = Patchcord
(Single Ended)
038 = Patchcord
(Double Ended)

Panel Sealing

TP = through panel sealing (for use
with PXP6033 panel body only)

Blank = not applicable

Characteristics

E = Earth lead (for use with PXP6033 plastic panel body only)
A = Glanding for PUR cable (for use with PXP6034 re-wireable flex only)
B = Glanding for 3.5 to 8mm cables (for use with PXP6034 re-wireable flex only)
2M00 = 2 metre cable length (for use with PXP6037 and PXP6038 patchcords only)
3M00 = 3 metre cable length (for use with PXP6037 and PXP6038 patchcords only)
5M00 = 5 metre cable length (for use with PXP6037 and PXP6038 patchcords only)

Examples

PXP6033TP/E= Panel mounted coupler, sealed through panel with earth lead

PXP6037/2M00= Patchcord with one sealed end, 2 metres long

PXM6034/A = Flex re-wireable connector for use with PUR cable

PXM6033TP = Panel mounted coupler, through panel sealed

Ethernet – Metal and Thermo-plastic versions

Connectors

Mechanical

Sealing	IP69K, DIN40050-9 IP68, EN60529:1992+A2:2013 (10m depth for 2 weeks) IP66, EN60529:1992+A2:2013
Salt Mist:	EN60068-2-52 Test Kb Salt Mist (Cyclic) Marine Severity Level 1
Operating Temperature	
Re-wireable and Metal	-20°C to +70°C
Overmoulded patchcords	0°C to +70°C

Materials - Overmoulded

Overmould material	PVC (black)
Flammability rating	UL94V-0

Materials - Re-wireable and Panel Connectors

Plastic	PC/PBT
Metal	Machined Brass, Nickel Plated
Flammability rating	UL94V-0
'O' rings	Silicone
Panel Gasket - round	Silicone
Panel Gasket - flange	Silicone
Approvals	

RoHS	Compliant
------	-----------

Stranded S-FTP Patch cord cable - PUR Jacket

Polyurethane (PUR) jacket cable with internal construction exceeding Cat 5e performance levels. The PUR jacket has excellent abrasion, chemical and ozone resistance, low smoke, low halogen flame retardant construction suitable for internal and external industrial environments.

Cable

Conductors	24AWG (7/0.2mm) bare copper
Insulation	HD-PE
Pair	2 of the above cores twisted
Core	4 of the above cores
Tape	1 lap mylar tape
Screen	1 layer mylar and aluminium tape, 0.12mm tinned copper braid
Sheath	PUR Jacket Black
Op Temperature	-25°C to +85°C
Min. bend radius	10 x o/d (installation)
Min. bend radius	6 x o/d (installed)
Diameter	6.1mm nominal

Electrical @ 20°C

Characteristic Impedance	100Ω ±15Ω @ 100MHz
Capacitance	330pF/km
Conductor Loop resistance	29Ω/100m maximum
Skew	45 nsec/100m @ 100MHz
TIA/EIA Rating	Cat 5e

Cable construction - PXP6037, PXP6038 and 14199

PCB adaptor leads

Electrical

No. of conductors	4
Current rating	1A
Voltage rating	30Vac (RMS)
Contact resistance	<10mΩ max.
PCB pitch	2.54mm

Materials

Moulding	Polycarbonate
Flammability	UL94V-0
Contact material	Copper Alloy
Contact plating	30 micro inch Gold
Wire insulation	PVC (black)
Flammability	UL94-V0
Conductors	4 x 28AWG
Operating temperature	0°C to +70°C
Mating cycles	1,000
RoHS	Compliant

Cable construction - PXP6040, PXP6041

